

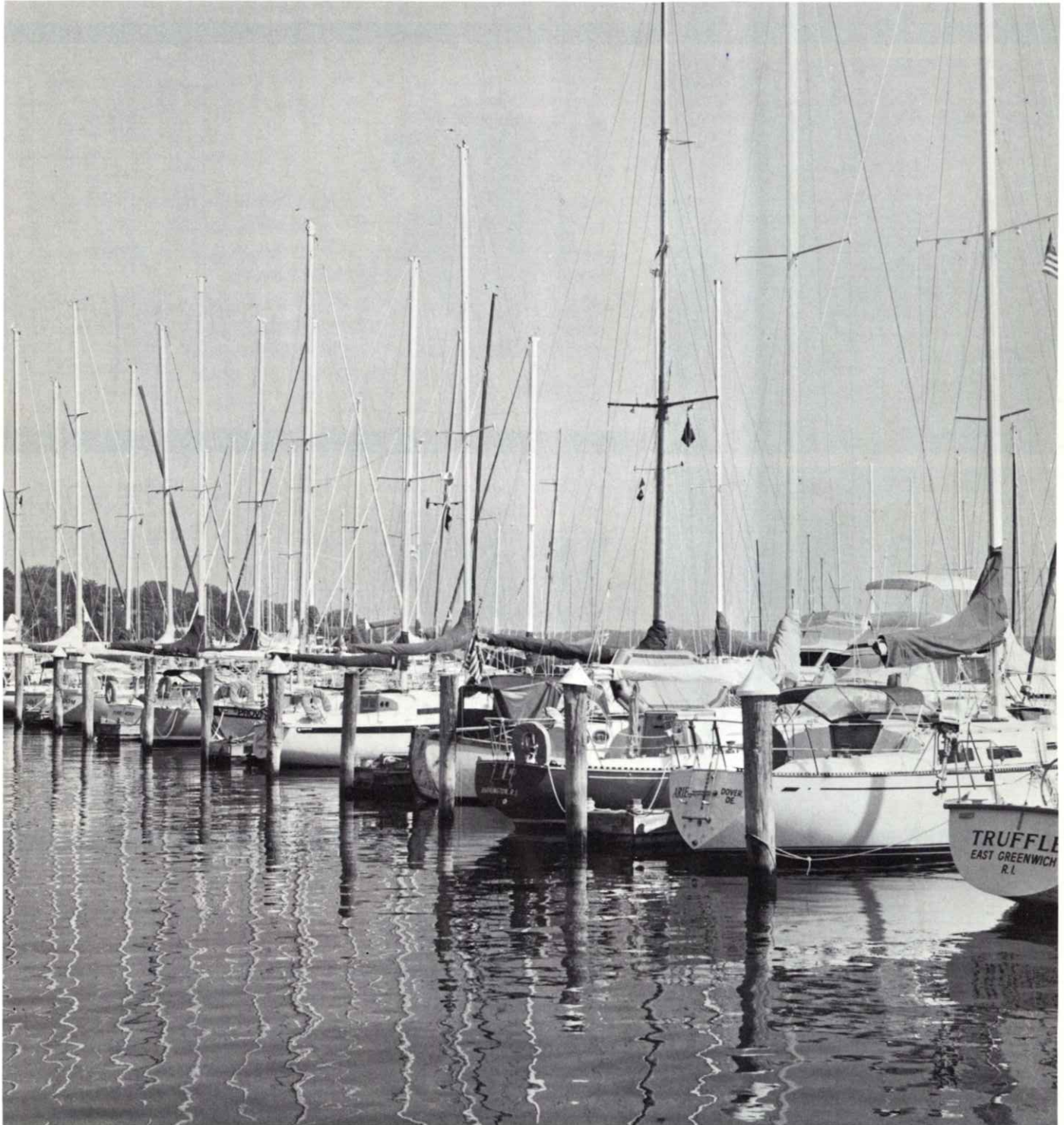

**J. H. WESTERBEKE CORP.**

**Small diesel auxiliaries**

**W-13 W-21 W-27 W-33**





**J. H. WESTERBEKE CORP.**

**Small diesel auxiliaries**

**W-13 W-21 W-27 W-33**

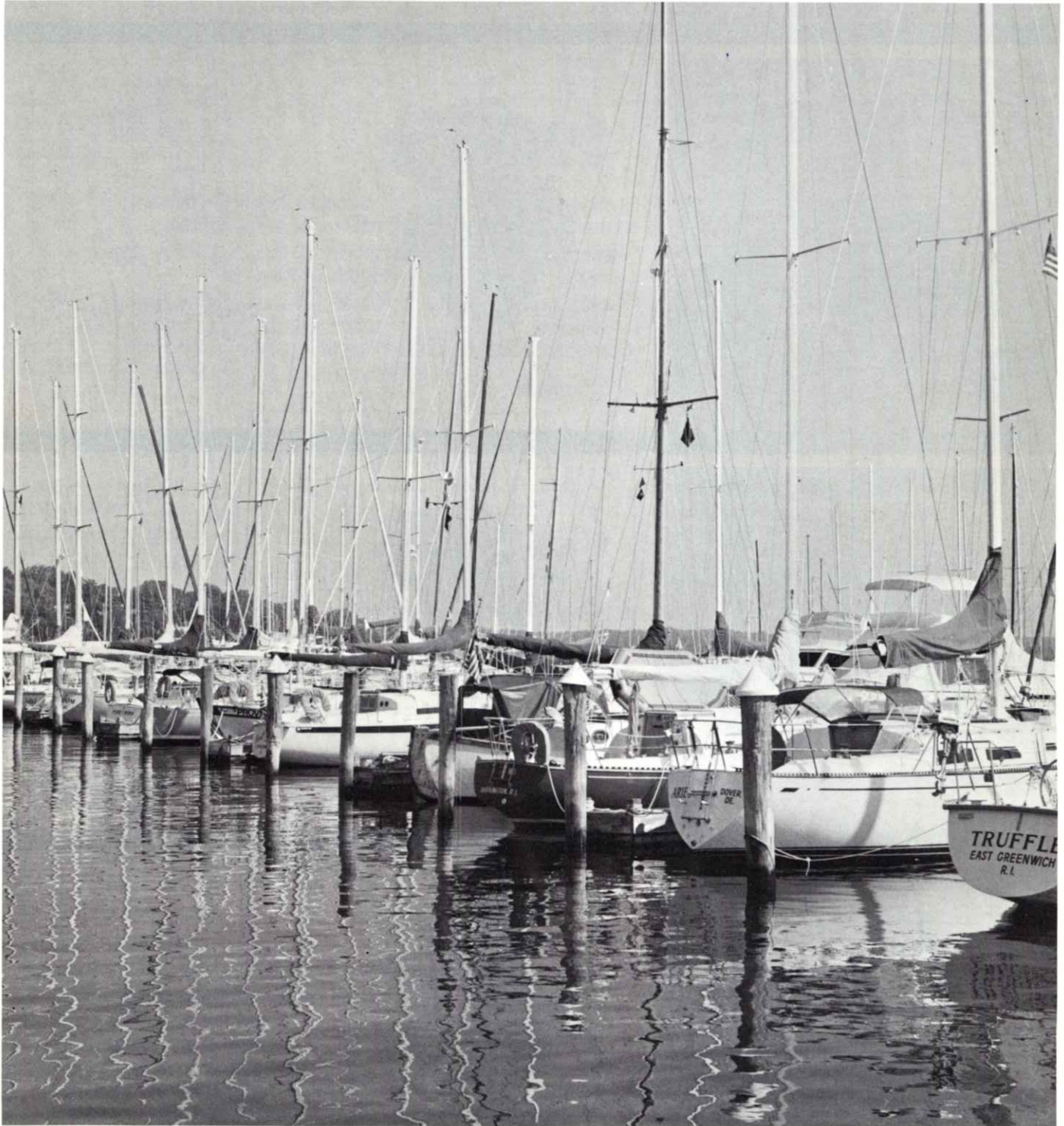

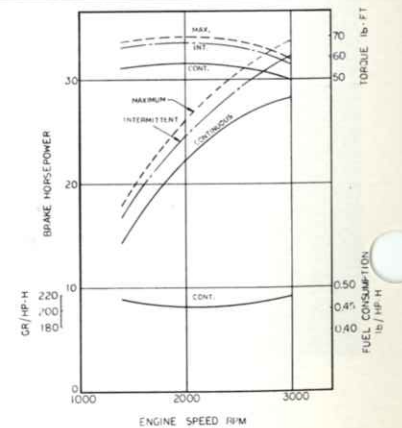
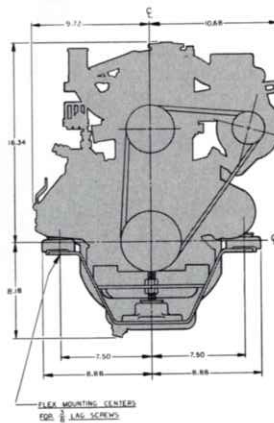
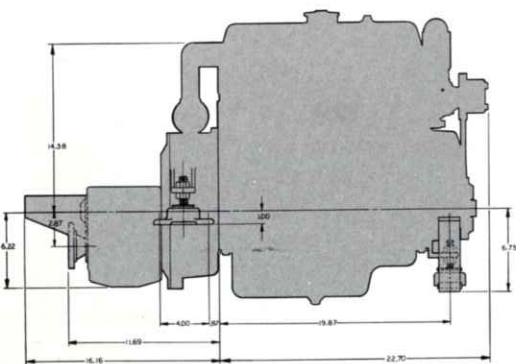
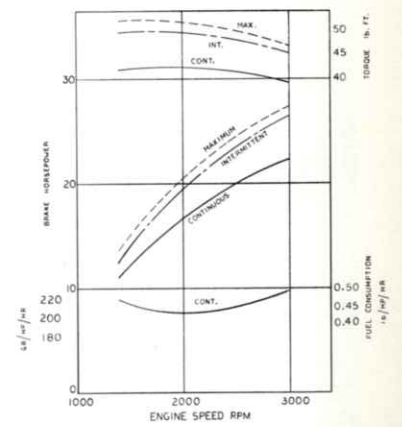
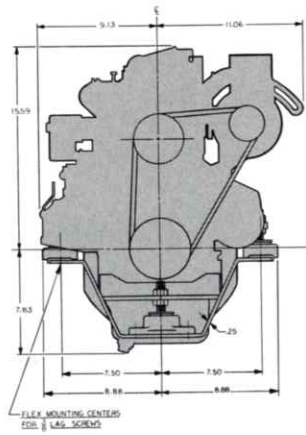
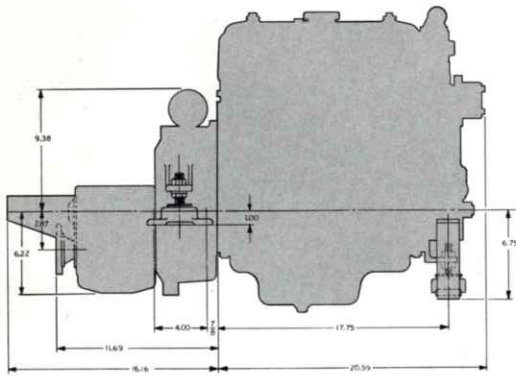
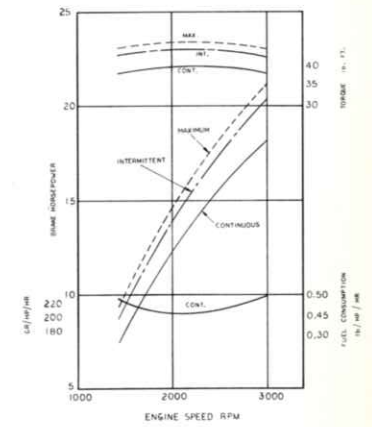
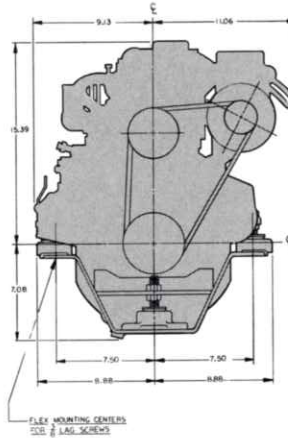
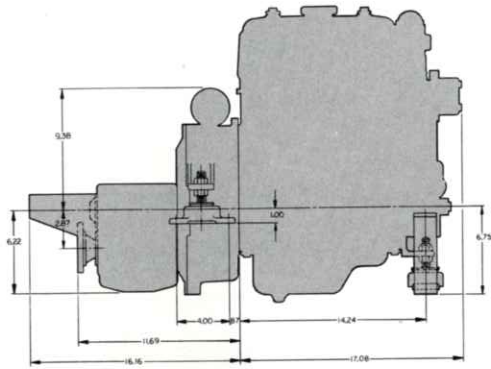
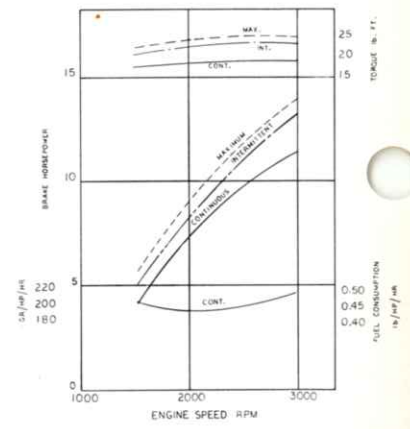
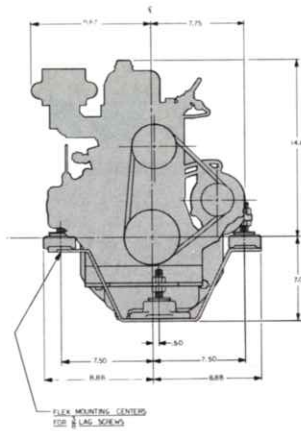
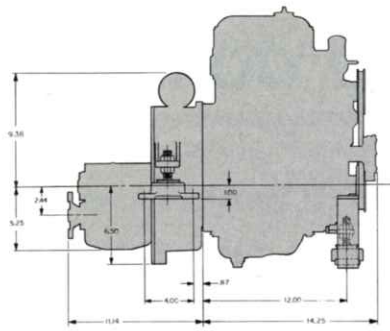

The W-13, W-21, W-27 and W-33 are a family of diesel auxiliaries offering standard features usually not found on engines in this range. By standardizing features WESTERBEKE can provide better parts availability and service to our customers and maintain our high standards of quality at a lower cost.

## W-13

Rated at 13.5HP, the WESTERBEKE 13 offers 2-cylinder smoothness in a lightweight package.

With a displacement of 37 cubic inches, the W-13 is well-suited to most yachts up to 32 feet.

Standard features not usually found on engines this size include fresh water cooling, 12V 50 amp alternator, cold weather starting aid, short profile sailing gear, push button priming and an electric fuel pump for dependability.

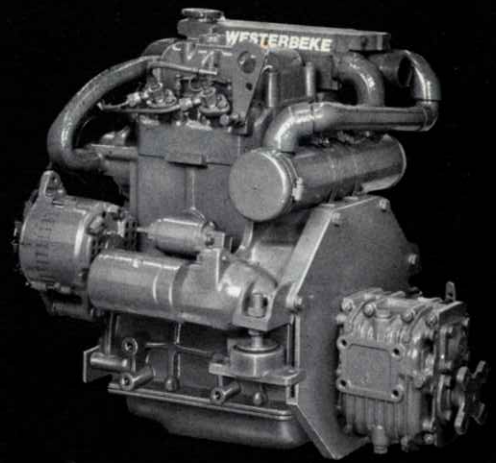

## W-21

The 3-cylinder WESTERBEKE 21 provides exceptional smoothness for sail auxiliaries in the 28 to 34 foot range.

Rated at 21HP, the W-21 mounts on 15" centers for easy installation in tight engine compartments.

Standard equipment includes fresh water cooling, cold weather starting aid, electric fuel pump for dependability, push button priming and prewired electrical system.

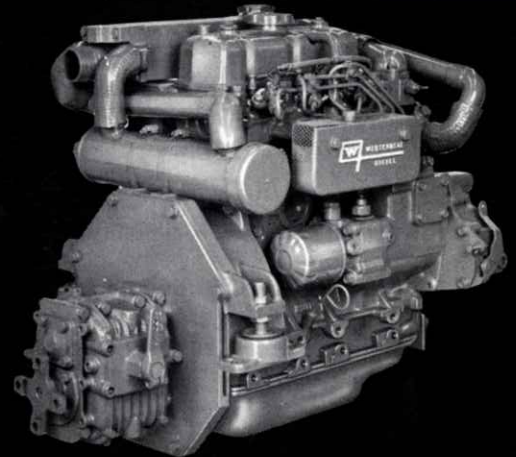

## W-27

Ideally suited for sail auxiliaries up to 37 feet, the WESTERBEKE 27 provides 4-cylinder smoothness and quiet.

This lightweight and compact engine mounts on 15" centers. Standard features include freshwater cooling for long engine life, factory prewiring, electric fuel pump, 12V 50 amp. alternator, throttle stop and shift brackets, cold weather starting aid and much more.

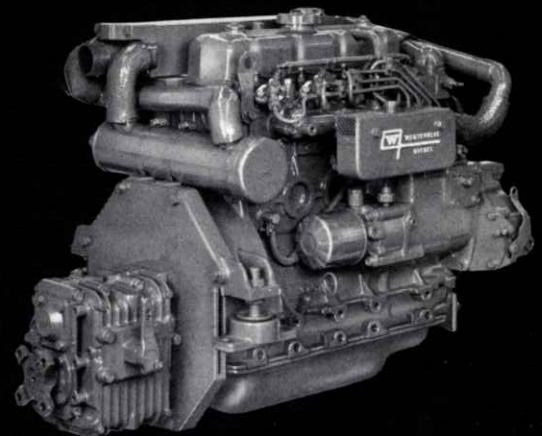

## W-33

A "big" small auxiliary, the WESTERBEKE 33 has a 91 cubic inch displacement, providing 33HP for yachts up to 40 feet.

This compact 4-cylinder engine offers smooth, quiet and efficient power to the standard short profile transmission. The W-33 features standard fresh water cooling, cold weather starting aid, prewired electrical system, adjustable flexible mounts, electrical fuel pump for dependability, push button priming, and more.

By mounting on 15" centers, the W-33 combines big engine efficiency in a truly compact configuration.

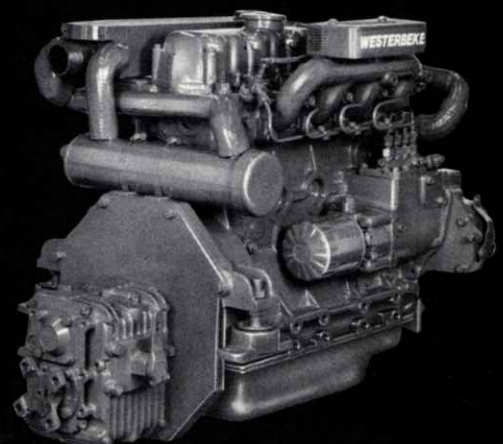

## SUPERIOR QUALITY AT AN EXCEPTIONAL PRICE

STANDARD SPECIFICATIONS	W-13	W-21	W-27	W-33
No. of cylinders	2	3	4	4
Displacement Cu. In.	37	60	80	91
Maximum Rated H.P.	13.5 @ 3000	21 @ 3000	29 @ 3000	33 @ 3000
Weight (lbs)	298	374	434	498
Transmission (Short Profile)	2:1 Std.	2:1 Std.	2:1 Std.	2:1 Std.
Mount Centers	15"	15"	15"	15"
Fresh Water Cooling	Standard	Standard	Standard	Standard
Electric Fuel Pump	Standard	Standard	Standard	Standard
Adjustable Flex Mounts	Standard	Standard	Standard	Standard
Alternator	12V 50 Amp.	12V 50 Amp.	12V 50 Amp.	12V 50 Amp.
Throttle/Stop/Shift Brackets	Standard	Standard	Standard	Standard
Propeller Shaft Coupling	Standard	Standard	Standard	Standard
Starting Aid	Standard	Standard	Standard	Standard
Prewired Engine	Standard	Standard	Standard	Standard
Operator Manual	Standard	Standard	Standard	Standard

- **Exceptional smoothness** — more cylinders per engine, high inertia flywheel, vibration isolating mounts.
- **Exceptional quietness** — custom designed, tuned intake silencer eliminates intake air noise; modern combustion chamber design eliminates diesel clatter.
- **No fuel system bleeding required** — Bosch-type fuel injection system and electric fuel pump, combined with Westerbeke's self-bleeding device eliminates engine bleeding.
- **Very light weight** — aluminum water-cooled exhaust manifold and flywheel housing.
- **Ease of maintenance** — removable end caps on heat exchanger for easy clean out, convenient oil drain system needs no hand pump, all wiring is tinned for corrosion resistance and led to a single 8-pin connector; heavy duty zinc anodes for heat exchanger.
- **Quality construction** — fresh water cooling with thermostatic controls, 50 amp alternator with radio shielding, metallic water piping wherever possible for endurance, cog-type alternator belts eliminate slippage, glow plug cold weather starting aid, oversized 3" diameter heat exchanger, shut-off function built into throttle control.
- **Excellent parts availability** — commonized parts on Westerbeke engines and generators means better service from an expanding network of stocking distributors and dealers.
- **Attractive accessories** — recessed 5-function, all electric instrument panel including TACHOMETER and HOURMETER, front exhaust capability for V-drives, accessory pulleys, coolant recovery tank for ease of monitoring and measuring coolant level, exhaust elbow, sea strainer, hydro-hush muffler, alternator output splitter.



## J. H. WESTERBEKE CORP.

Avon Industrial Park, Avon, MA 02322, (617) 588-7700  
Cable: Westcorp, Avon, Telex: 92-4444

Although all descriptions and pictorial representations of the products herein are believed to be correct at the time of publication, accuracy cannot be guaranteed. The policy of J. H. Westerbeke Corporation, is one of continued improvement. Therefore, equipment, colors, materials and other specifications, model availability and prices are subject to change without notice or obligation.