

# SOUND GUARD SST-E INSTALLATION INSTRUCTIONS & PARTS LIST

FOR DIESEL GENERATOR MODELS 8.0-10.0, 11.5, 12.6 EDT



# SOUND GUARD SST-E INSTALLATION INSTRUCTIONS & PARTS LIST

## FOR DIESEL GENERATOR MODELS 8.0-10.0, 11.5, 12.6 ETD

### INTRODUCTION

Westerbeke's SOUND GUARD SST-E for D-NET diesel generators consists of five aluminum powder-coated panels and a stainless steel base. The panels are lightweight and easy to clean. They attach to a stainless steel frame and to the base to form a high quality rigid, compact, sound-insulated enclosure for your generator. The front and rear end panels each have a plenum attached to allow the entry and circulation of cooling air inside the SOUND GUARD SST-E.

The base serves as a drip pan. A drip pan is an important part of your generator installation. Not only will it help maintain a clean compartment, but drip pans are also required in marine installations.

Assembling Westerbeke's SOUND GUARD SST-E is quick and easy, even in close quarters. A flat-head and a Philips head screwdrivers are required to assemble the stainless steel frame. The panels require no assembly and can be easily removed for inspection and servicing. If necessary, the entire enclosure can be disassembled in just a few minutes.

The base and frame contain bulkhead fittings for all the generator's external connections including the raw water line, siphon break, fuel lines, exhaust line, AC wiring, and battery cables. Westerbeke supplies the necessary hoses, cables and hardware to make these connections, allowing quick and easy "plug-and-play" installations. AC wires are brought through the SOUND GUARD SST-E via grommet then up to AC side of panel box where they attach to the terminal block.

There are pre-drilled mounting holes in the bottom of the base. Use the appropriate holes to mount the generator and the SOUND GUARD SST-E onto the bed/platform.

Included with the SOUND GUARD SST-E is a cover plate to be installed at the bottom-rear of the generator's housing to cover two rectangular holes. See Fig. 1. This is necessary to prevent the recirculation of heated air within the enclosure. *This cover plate must be installed.*

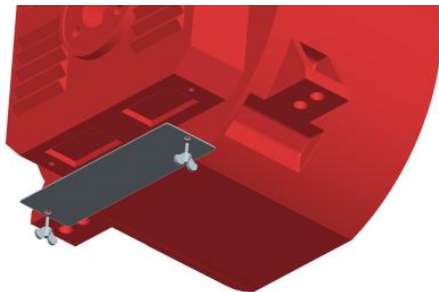
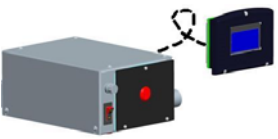



Fig. 1

The SOUND GUARD SST-E utilizes the large capacity fan between the engine's flywheel and the generator to supply air for cooling, and to evacuate air from the SOUND GUARD SST-E. The installation must be planned so there is a free circulation of air around the outside of the SOUND GUARD SST-E. Clearance should also be planned to facilitate removal of any panel.

### PREPARING THE GENERATOR FOR THE SOUND GUARD

1. Uncrate the SOUND GUARD SST-E, and find the following: base, front and rear frame, two frame supports, two side panels, front and rear panels, top panel, and cover plate kit. This SOUND GUARD SST-E also includes several hoses, cables and necessary hardware to make external electrical, fuel and water connections cleanly and easily. Installer supplies the generator mounting hardware.
2. Uncrate the Genset.
3. Remove the belt guard from the front of the generator's engine. Interference with the SOUND GUARD SST-E enclosure and poor air circulation will result if the belt guard is not removed. *The belt guard must be removed.*
4. **WARNING:** The digital display must be removed from the panel box when generator is installed in a SOUND GUARD SST-E. Failure to do so may cause damage to the display from excessive heat, this type of failure is not covered under the limited warranty. There are a few options:

1	Remote-mount the digital display with extension cable to a desired location and seal the panel box opening with a cover plate. (Kit: 53341)	
2	Remote-mount the digital display with extension cable to a desired location and install an analog start/stop switch. (Kit: 53342)	
3	Remote-mount digital display on the SOUND GUARD SST-E service side access panel. (Kit: 53488)	

- Remove the inlet bracket on the side of panel box. See [Fig. 2](#).

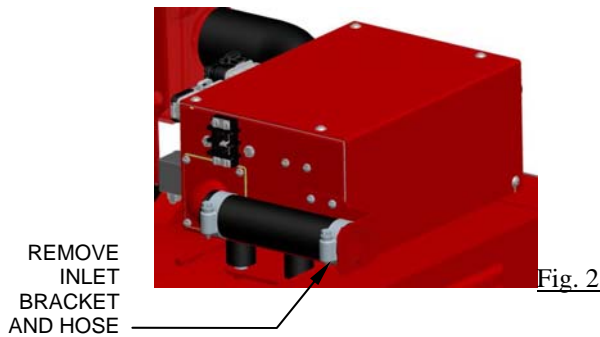

- Reinstall the bracket screws on the panel box to close the tapped holes. See [Fig. 3](#).

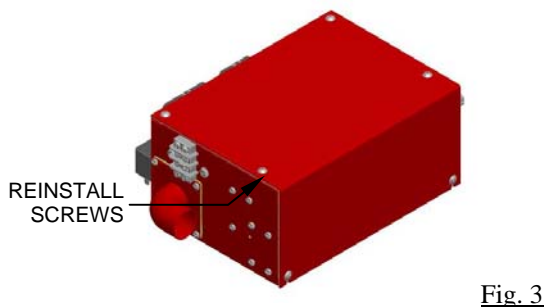

- Install the cover plate onto the bottom of the generator housing with the two thumbscrews supplied (applies to all BTD Generator models). See [Fig. 1](#)
- Remove the two screws on the AC circuit breaker box cover that will be behind the new SOUND GUARD SST-E's rear frame. These two screws are not necessary and will allow the circuit breaker box cover to be removed more easily.

#### INSTALLING THE GENERATOR AND SOUND GUARD SST-E

Note: For additional mounting information, see Westerbeke's *INSTALLATION MANUAL for MARINE ENGINES & GENERATORS*, Publication #43268.

- Select the four mounting holes in the SOUND GUARD SST-E's base that apply to your particular generator model.
- When adding the SOUND GUARD SST-E to an existing generator installation, place the SOUND GUARD SST-E's base on the bed (or platform) and align the four selected mounting holes in the base with the four existing mounting holes in the bed/platform.

For a new installation, place the SOUND GUARD SST-E's base on the bed/platform, then drill down into the bed/platform using the four selected mounting holes in the base as a guide.

- Lower the generator onto the base, aligning the four selected holes in the generator's rails with the four mounting holes in the base. Make sure the generator end of the unit faces the rear panel of the SOUND GUARD SST-E. If installing onto a platform, mount with hex bolts from below the platform. Use stainless steel bolts, washers and nuts.
- Install front and rear frame and leave screws loose until all are in place.
- Install and connect the provided hoses and cables between the engine/generator and appropriate bulkhead fittings located on the base and rear frame sections. Use the following checklist to ensure all internal connections are made. See [Fig. 5](#). **Note:** The molded exhaust hose may need to be trimmed depending on the particular generator model.
  - \_\_\_ Battery Cable, Positive (to starter motor)
  - \_\_\_ Battery Cable, Negative (to engine block ground)
  - \_\_\_ Genset Ground Cable (to engine block ground)
  - \_\_\_ 1/4" Fuel Supply Hose (to fuel lift pump)
  - \_\_\_ 1/4" Fuel Return Hose (from engine)
  - \_\_\_ 1" Raw Water Inlet Hose (to raw water pump)
  - \_\_\_ 1" Raw Water Hose (from heat exchanger to siphon break)
  - \_\_\_ 1" Raw Water Hose (from siphon break to water injected exhaust elbow)
  - \_\_\_ Air Inlet Hose (to panel box)
  - \_\_\_ 2" Exhaust Hose, Molded

- Next, make the external connections between the vessel and SOUND GUARD SST-E. Before attaching the side panels, it is a good idea to start the generator and check for any leaks.
- After the generator has been connected and operates properly, assemble the SOUND GUARD SST-E panels using the illustrations as a guide.

**Note:** When assembling the panels, make sure they seat properly onto the base edge gasket.

**Caution:** A D-Shaped foam rubber gasket has been installed on the plenum of the rear panel to provide a tight seal between the plenum and the generator air inlet grill. This is to prevent hot air from recirculating and overheating the generator. Make sure this gasket has not been damaged.

- Line up the panel latches with the holes in the SOUND GUARD SST-E frame. Firmly hold the panel against the frame to compress the panel gasket and then close the latch. Latch tension can be easily adjusted by either tightening or loosening the plastic nut on the latch (putting more or less initial tension on the rubber swell bushing).

Installation of the SOUND GUARD SST-E is now complete.

Review the final installation checklist and insure all items are complete:

- \_\_\_ Cover Plate Kit is installed on the bottom of the generator housing.
- \_\_\_ Plastic belt guard is removed from the engine.
- \_\_\_ Remote-mount the digital display.
- \_\_\_ All cables and hoses are tight with no leaks.
- \_\_\_ Generator gasket on the rear panel seals properly.
- \_\_\_ None of the air inlets or outlets is blocked.
- \_\_\_ There is enough space around the enclosure for proper cooling and removal of panels.
- \_\_\_ All the electrical connections are connected properly and connections are secured.

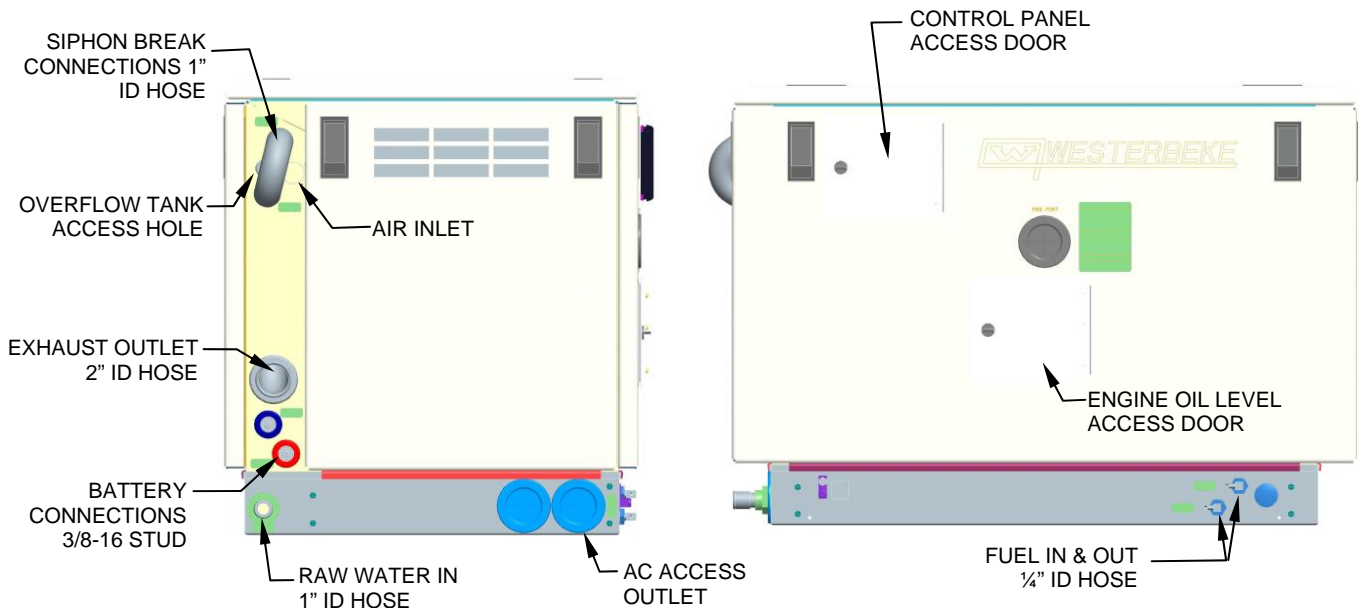

Fig. 5

**SOUND GUARD SST-E FOR GENERATOR 8-10, 11.5, 12.6 EDT PARTS LIST**  
 When ordering parts, provide Part Number, Name and Quantity for each part needed.

REF.	PART #	PART NAME	QTY	REF.	PART #	PART NAME	QTY
1	49492	Base (includes connectors)	1	23	49546	Terminal, Battery Pos.	1
2	49491	Panel, Front	1	24	49544	Terminal, Battery Neg.	1
3	49493	Panel, Rear	1	25	49661	Cable, Ground	1
4	49496	Panel, Top	1	26	49659	Cable, Battery Pos.	1
5	49494	Panel, Side	1	27	49660	Cable, Battery Neg.	1
6	49495	Panel, Service Side	1	28	39498	Grommet, Neoprene	3
7	49504	Frame, Rear	1	29	42806	Plug, Drain Hose Access	1
8	49503	Frame, Front	1	30	49545	1/8 NPT Bulkhead Fitting	2
9	49505	Frame, Support	1	31	48484	Elbow, 1/8 NPT x 1/4 Hose	5
10	53458	Frame, Support Service Side	1	32	22927	Hose, Fuel 1/4 ID	as req.
11	49535	Screw, 10-32 x 1/2 flat head	12	33	24906	Clamp, Fuel Hose	4
12	49536	Screw, 10-32 x 3/8 hex slot	16	34	48193	1/2 NPT Bulkhead Fitting	3
13	49540	Latch Assembly	8	35	36618	Nipple, 1/2 NPT x 1 Hose	6
14	49537	Latch Assembly (front & rear panels)	4	36	11779	Hose 1" Wire Inserted	as req.
15	49547	Gasket, Base Edge	as req.	37	11405	Clamp, Raw Water Hose	8
16	49548	Gasket, Panel Edge	as req.	38	37298	Cover Plate Kit	1
17	43574	Gasket, Generator (on rear panel)	as req.	39	52962	Grommet, Overflow Tank Hose	1
18	42815	Elbow, Exhaust Outlet 2"	1	40	38064	Hose, Air Inlet	1
19	49561	Hose, Exhaust 2" Molded	1	41	52730	Flange, Air Inlet	1
20	42782	Grommet, Exhaust Outlet	1	42	31940	Screw 6-32x3/8 Sems	4
21	11411	Clamp, Exhaust Hose	4	43	53077	Door Kit, Service Side Panel	1
22	49543	Terminal, Ground Lug	1				

