

ALTERNATOR, 40A-24VDC

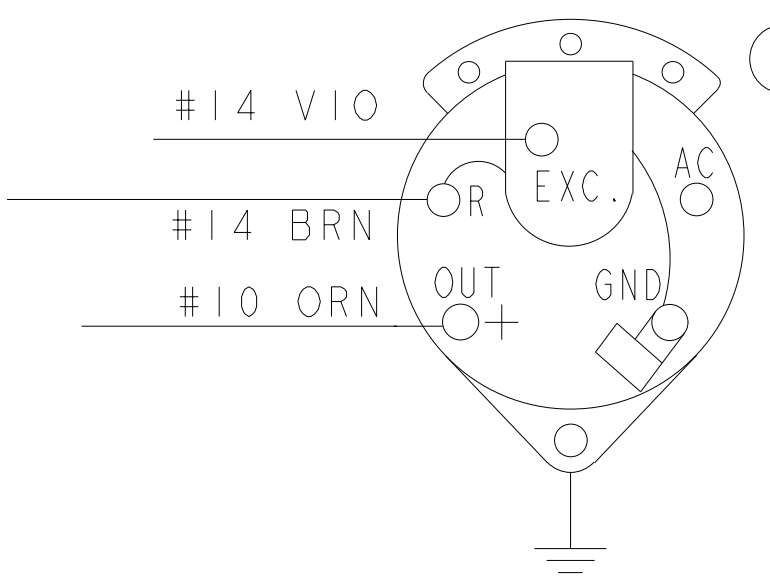

WATER TEMPERATURE SWITCH

ALTERNATOR, 50A-12VDC

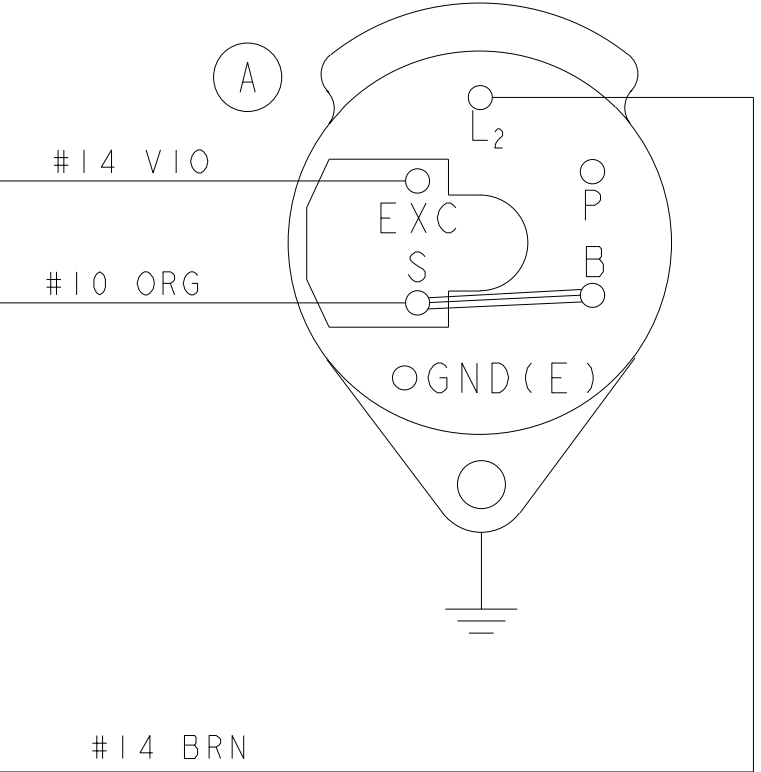

GLOW PLUGS

WATER TEMPERATURE SENDER

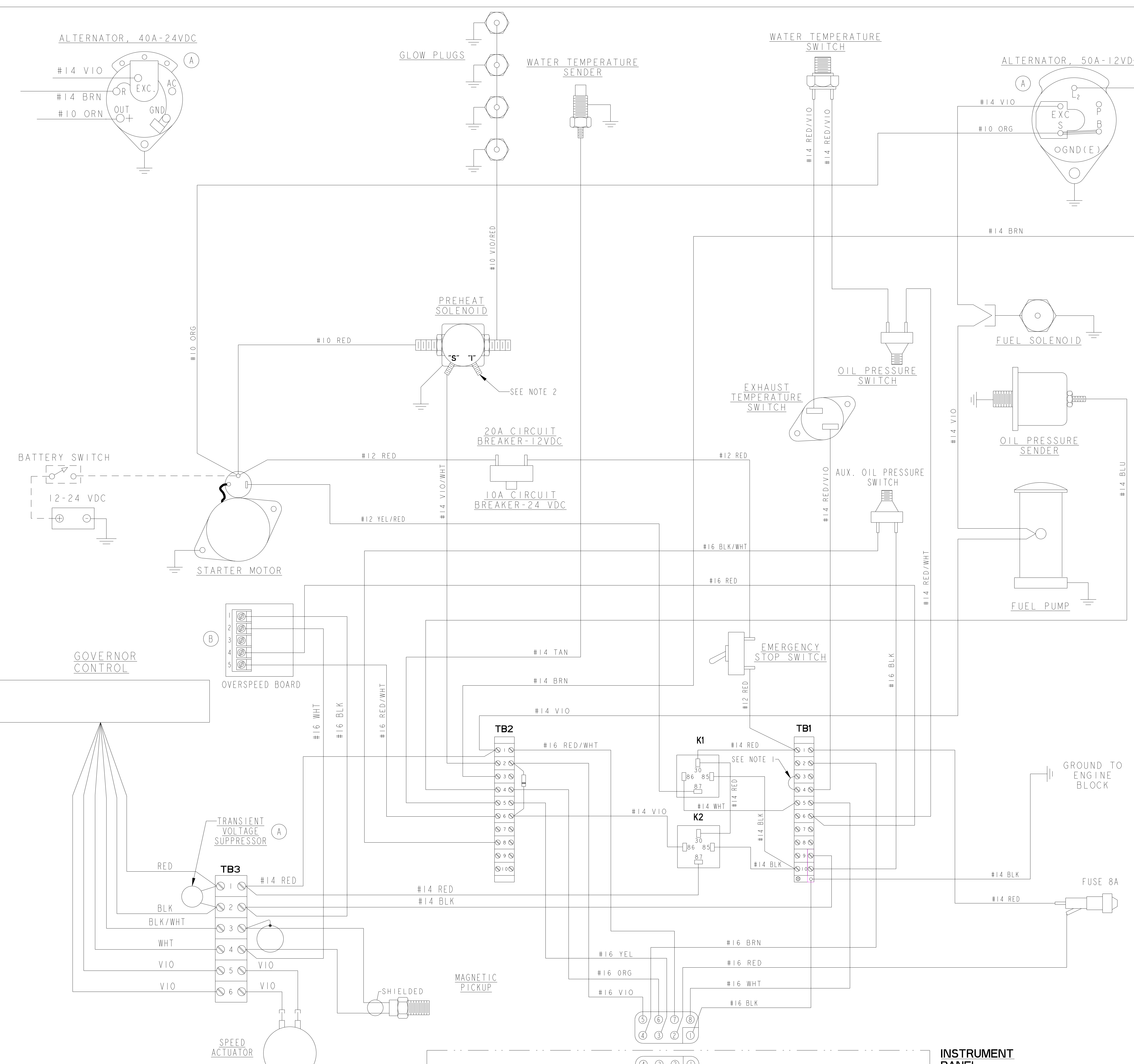
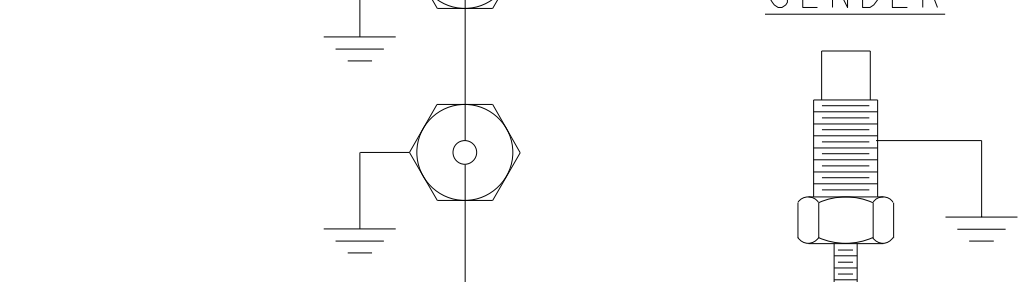

NOTE:
 1. REMOVE JUMPER WHEN CONNECTING A SECOND REMOTE PANEL.
 2. GROUND "1" TERMINAL OF PREHEAT SOLENOID ON 24V SYSTEM ONLY.

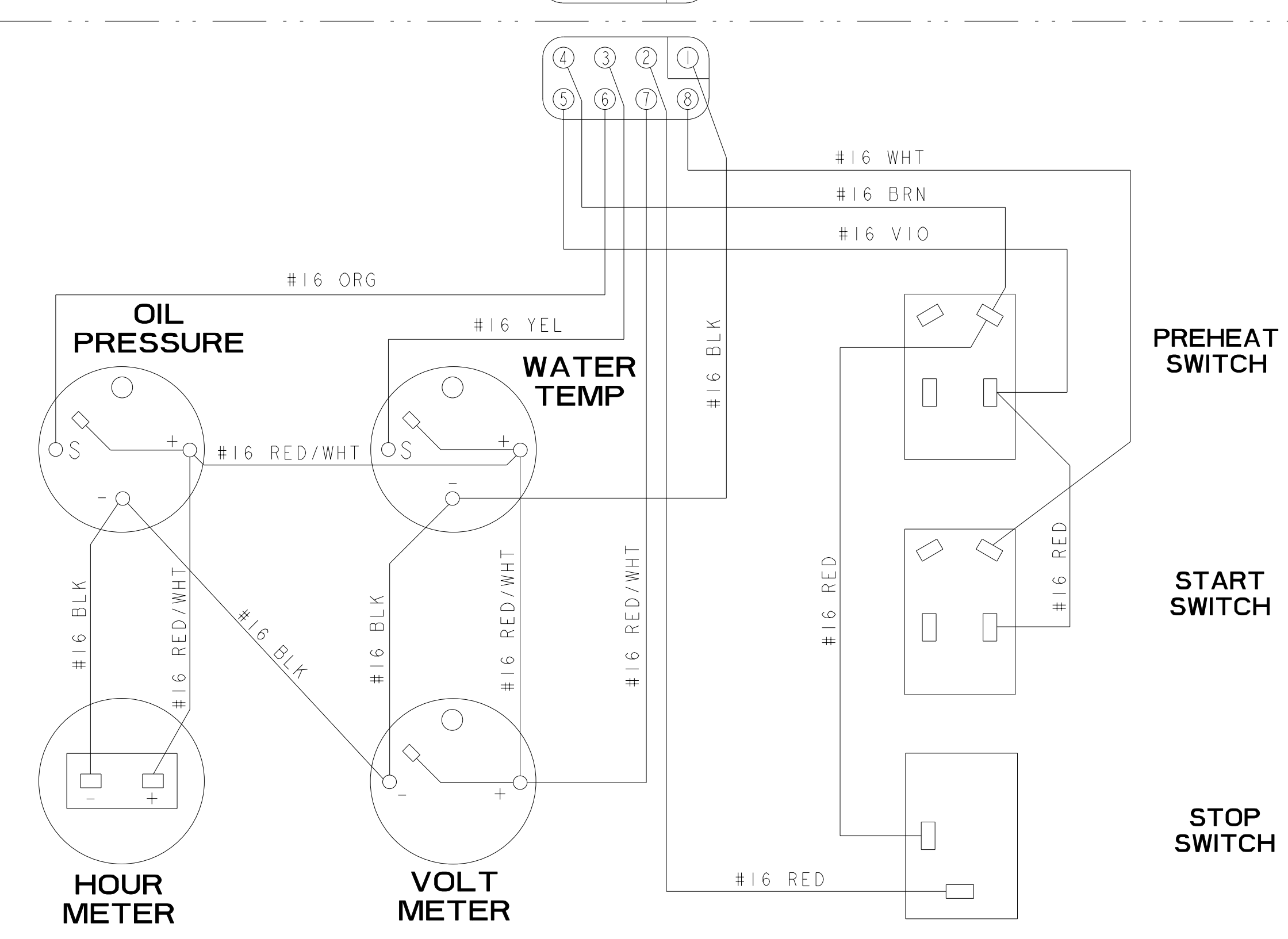
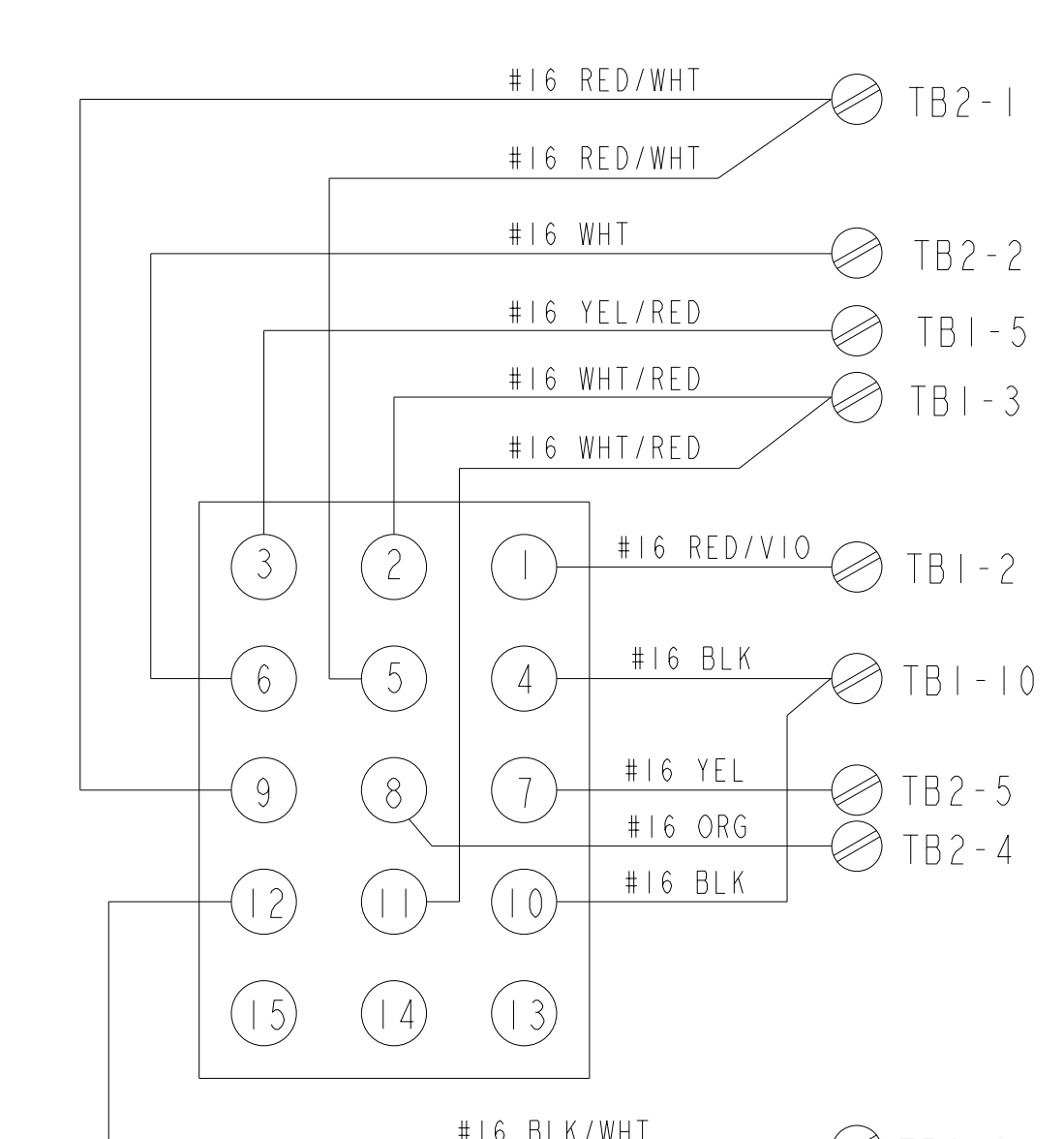

INSTRUMENT PANEL

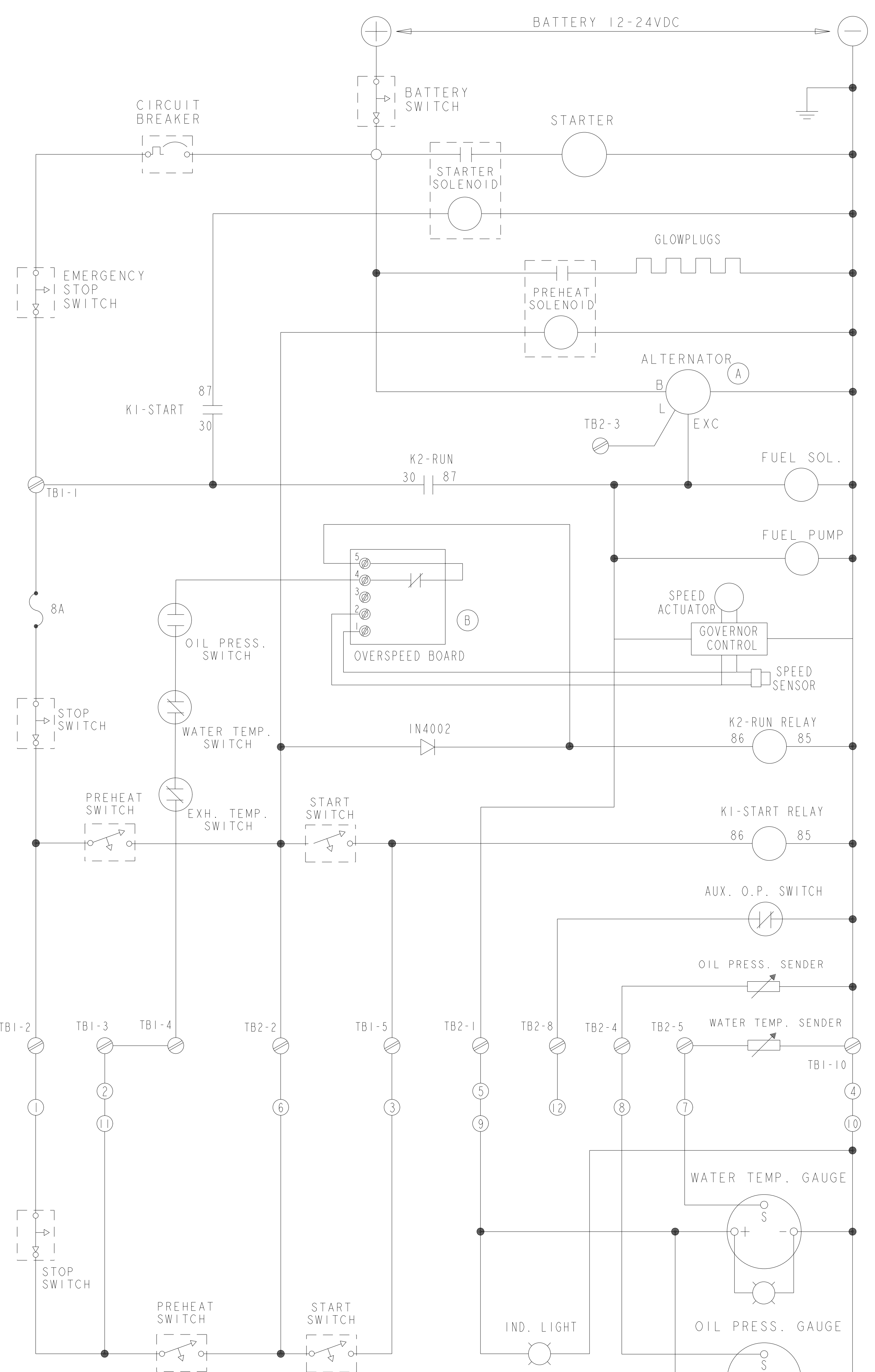

-TYPICAL REMOTE START/STOP PANEL CONNECTIONS-

NOTE:
 ○ REMOTE CONNECTOR PINS

5536 4-25 2003 B		ADDED OVERSPEED BOARD	GA
4632 7/12 86 A		UPDATED ALTERNATOR WIRING SCHEMATIC. ADDED TRANSIENT VOLTAGE SUPPRESSOR TO CIRCUIT.	TSM

TOLERANCES UNLESS OTHERWISE NOTED:		WESTERBEKE CORPORATION AVON MA. 02322	
INCHES	MILLIMETERS	TITLE WIRING DIAGRAM/SCHEMATIC, 20.0 BEDA, 25.0 BED - SRC	
.XX	.00	DATE	DRAWN BY
.XXX	.005	DATE	APPROVED BY
ANGLES	.XX	DATE	DATE
FINISH	Ø	DATE	DATE
DIMENSIONS INCHES MILLIMETERS		SCALE NONE	
(WHEN APPLICABLE)		SIZE DRAWING NUMBER	
		SHT. 1 of 1	
		E 44736 B	